

**4W MOBILE CB TRANSCEIVER**

**TCB-900**

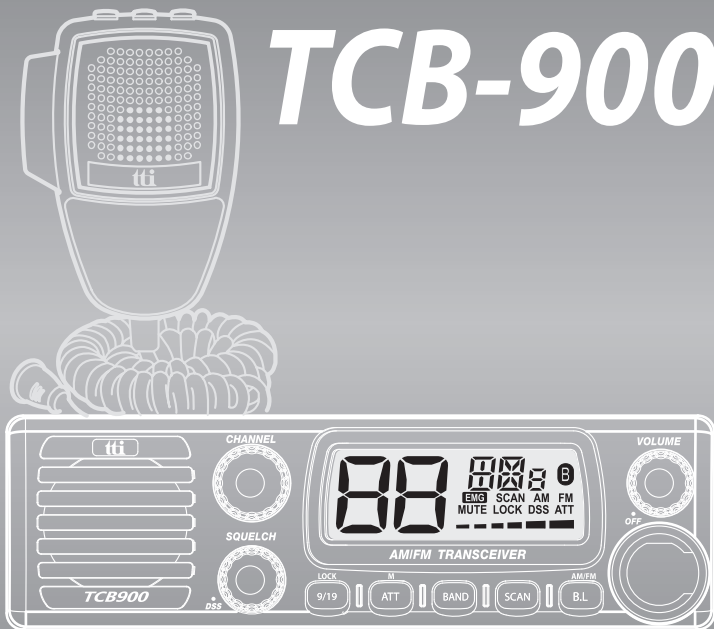

**I N S T R U C T I O N M A N U A L**

**tti**

[www.ttikorea.co.kr](http://www.ttikorea.co.kr)

# Our Thanks to You and Customer Assistance

## Our Thanks to You

### Our Thanks to You

---

**Thank you for purchasing a TTI CB TRANSCEIVER radio. Properly used, this TTI product will give you many years of reliable service.**

All our products are built to offer excellent value by combining advanced features, great design and manufacturing quality.

To ensure you are familiar with the operation and features of your radio, and in order to obtain the best performance, please read this manual carefully before operation.

# Contents

## Contents

1. Introduction .....	4
2. Supplied Accessories .....	4
3. Installation .....	4
4. Transceiver Controls and Functions.....	7
1) Front Speaker .....	8
2) Channel Selector .....	8
3) LCD Display .....	8
4) Volume and Power On/Off Knob .....	8
5) Microphone Jack .....	8
6) Backlighting and AM/FM .....	8
7) Scan .....	9
8) Band(Selection) .....	9
9) Attenuation and Menu(M) .....	10
10) Emergency(9/19) and Keypad Lock .....	12
11) Squelch Control and DSS(Dynamic Squelch System) ...	12
12) Antenna Connector .....	12
13) EXT Jack(External Speaker Jack) .....	12
14) Power 13.2 VDC .....	12
5. LCD Display .....	13
6. Microphone .....	13
7. How to Operate the Transceiver .....	14
8. Trouble Shooting .....	14
9. CE Declaration .....	14
10. Safety Requirement .....	15
11. Specification .....	16
12. Restrictions on the use .....	17
13. Declaration of Conformity .....	18

# Introduction

## 1. Introduction

TCB-900 transceiver is designed to have a good performance in any conditions that the transceiver operates, using rugged build chassis, PCB's and components. This transceiver is also designed for users' convenience, implementing human ergonomics to locate the knobs and buttons in the proper places. The combination of well designed knobs and buttons as well as user friendly graphic layouts will lead users to quickly adapt themselves for the easy operation. The newly applied menu mode will make professional users more satisfactory with pleasure. The elegant luxury and color changeable LED light supporting the face design will go well with any vehicles.

This instruction manual has been designed to enable you to get the best use from your CB Transceiver, therefore you are recommended to take a few minutes to read this instruction manual before initial use of your CB Transceiver.

## 2. Supplied Accessories

Your transceiver is supplied with a full range of accessories to help you get started and virtually benefit from all the features straight away.

TCB-900 transceiver	1 unit
Microphone with cord	1 unit
Power cable	1 unit
Radio mounting bracket	1 unit
Radio mounting thumb screw with rubber washer	2 pieces
Mounting screw & washer(for transceiver bracket)	3 pieces
Mounting screw & washer(for microphone bracket)	3 pieces
Microphone mounting bracket	1 piece

## 3. Installation

Plan the location of the transceiver and microphone first, which is most convenient for the operation. The transceiver should normally be mounted horizontally, but may be mounted vertically. The bracket supplied can be fitted above or below the case allowing the TCB-900 to be cradled by the bracket or suspended from it.

# Installation

Consider that this location of the transceiver should not interfere with the driver and passengers. Choose a spot where the microphone and all controls are easily accessible.

(1) Put the mounting bracket on the proper location where you are going to install.

Drill holes and fix mounting bracket on the location.

(2) Connect the antenna cable plug to the standard receptacle on the transceiver, which is marked "ANT".

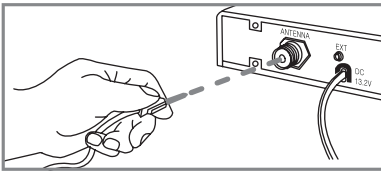

(3) Connect the power cable directly to the vehicle battery or fuse box of the car. Be careful to make sure of the polarity of the battery first and connect the cable. (Red: Positive Pole(+), Black: Negative Pole(-). The same colours are shown on the battery and in the fuse box of the car.)

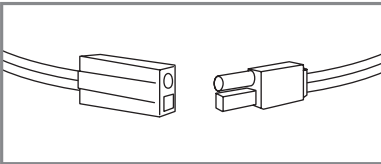

(4) Connect the power cable to the transceiver cable.

(5) Mount the microphone bracket on one side of the transceiver, or near it using two screws included.

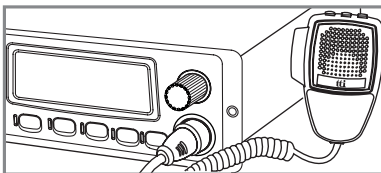

Connect the microphone to the transceiver's microphone receptacle. Now you are ready to operate the transceiver.

# Installation

## Installing an Antenna

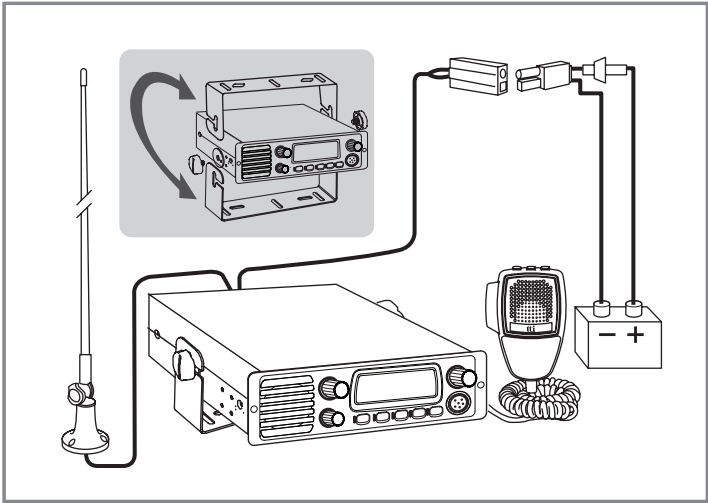

It is very important to select a good quality high efficiency 27MHz antenna. A poor quality antenna or one not designed for the 27MHz band will give very poor performance and could cause damage to the transceiver.

- (1) Place the antenna as high as possible.
- (2) The longer the antenna is, normally the better is the performance of the transceiver.
- (3) Try to mount the antenna in the centre of the surface that you select.
- (4) Make sure that you have a solid metal-to-metal ground connection.
- (5) Be careful not to damage the cable during the installation.

**Warning :**Never try the operation of your transceiver before connecting a proper antenna in order not to cause any damage.

# Transceiver Controls and Functions

## 4. Transceiver Controls and Functions

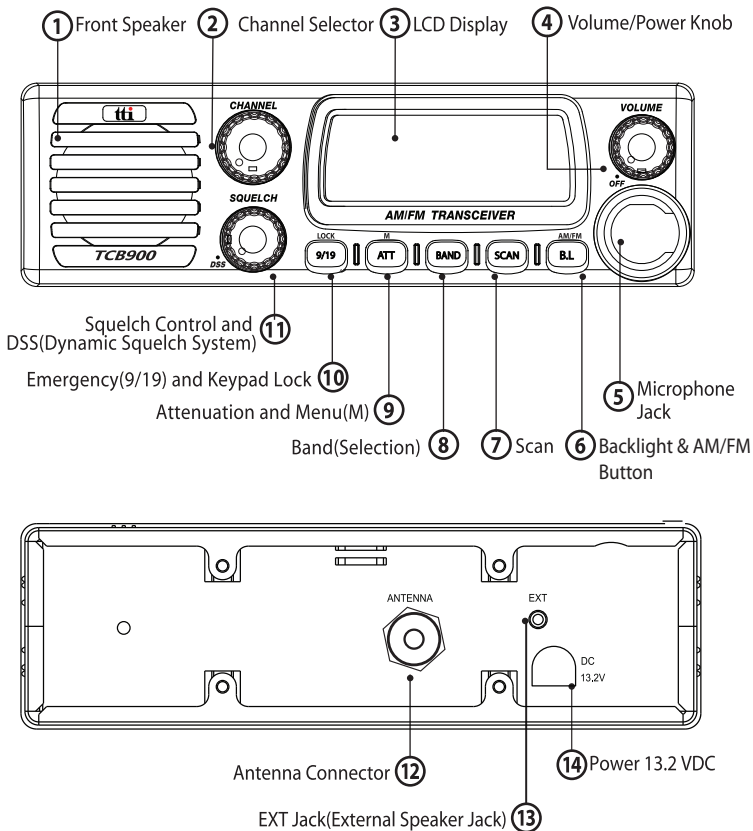

# Transceiver Controls and Functions

## Front Speaker

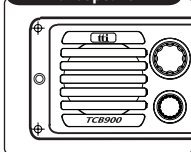

### 1) Front Speaker

The front speaker makes the audio always loud enough even when the transceiver is located in the audio compartment(center fascia) or in some places difficult to be found.

## Channel Selector



### 2) Channel Selector

Turn right or left, and this allows you to move the channel one by one for you to select one that you like to use.

## LCD Display



### 3) LCD Display

Most of the operational information is displayed. Please see item no. 5 for the details of information.

## Volume & Power Knob

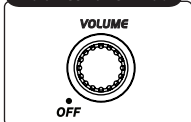

### 4) Volume & Power On/Off Knob

To switch on the transceiver turn this knob clockwise. After clicking sound the transceiver is switched on. The more you turn this knob clockwise, the bigger the audio sound grows.

## Microphone Jack



### 5) Microphone Jack

Insert the microphone into this jack. Use the guide for easy connection.

## Backlighting & AM/FM

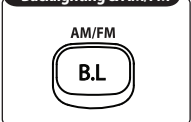

### 6) Backlighting and AM/FM

**Backlighting:** Three colours are available for user selection. The colours include blue, purple and amber. Momentarily press this button to change the colour.

**AM/FM:** This button allows user to switch between AM and FM modes by pressing this button for about 2 seconds.



# Transceiver Controls and Functions

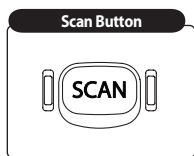

## 7) Scan Button

Press this button momentarily to start scanning upward to catch any channels that are occupied by others.

To activate/deactivate the channel scan, press the Scan button briefly. The Scan icon will appear when the channel scan is active. Scanning will only stop when you deactivate the scan function.

Turn the channel selector counter-clockwise during scanning in order to change the scanning direction.

The transceiver will scan through the whole transceiver channels. If your transceiver detects a valid signal the scan will pause for the period that has been set by the menu mode setting (1-99 seconds or unlimited for scan receive time and 0-99 seconds for scan delay time).

If you press the PTT button when your transceiver detects a signal, the radio will transmit on the same channel. Scanning will resume after the scan receive time and/or the scan delay time. Use the channel selector to resume scanning immediately.

If you press the PTT button during scanning, the radio will return to your original channel. Scanning will resume after the scan receive time and/or the scan delay time. Use the channel selector or quick up/quick down selector to resume scanning immediately.

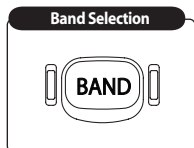

## 8) Band Selection

Momentarily press this Band button, The LCD display offers you the band information. The band chart for each area is as follows.

Turn the channel knob while the band information is blinking and press the PTT button or just wait for about 10 seconds for your selection confirmation. This transceiver has "EC" band setting when it is shipped out from the factory.

# Transceiver Controls and Functions

Setting	Display	Settings
EC	EC	Europe 40 Ch. FM 4W
E	E	Spain 40 Ch. AM/FM 4W
F	F	France 40 Ch. FM 4W, 40 Ch AM 4W
PL	PL	Poland 40 Ch. AM / FM 4W (Polish Frequencies : 5KHz)
UK	UK	UK 40 Ch. FM 4W (British Frequencies)
UE(EU/UK)	UE	UK 40 Ch. FM 4W (British Frequencies) +CEPT 40Ch. FM 4W(EC)
I	I	Italy 40 Ch. AM / FM 4W
I2	I2	Italy 34 Ch. AM / FM 4W
D	d	Germany 80 Ch. FM 4W, 40 Ch. AM 4W
D2	d2	Germany 40 Ch. FM 4W, 12 Ch. AM 4W
EU	EU	Europe 40 Ch. FM 4W, 40 Ch. AM 4W

## (9) Attenuation and Menu Button

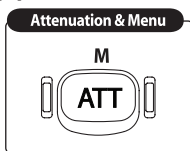

**Attenuation:** Momentarily press this ATT button to activate about 10dB attenuation of the receiving signal strength. This is normally used in the area where the signal strength is too strong. The ATT icon on the LCD will show up during this activation. To return to the normal receiving mode, momentarily press this button again.

**Menu:** The menu mode allows you to set up and edit the selectable functions. To access the menu mode, press and hold this button, and afterwards each press of the menu button steps the transceiver sequentially through the different functions. The LCD display indicates the current functions. The present setting and associated icon(s) flash. Use the channel selector to change the setting. Press the PTT or menu button or wait for about 10 seconds to store the changes you have selected. If you do not press any button or knob for about 10 seconds, your transceiver will return to the standby mode automatically.

# Transceiver Controls and Functions

Display	Functions	Settings
	Microphone Gain	High( <b>Hi</b> ) and Low( <b>Lo</b> )
	Beep Tone	On( <b>ON</b> ) and Off( <b>OFF</b> )
	Time-out Timer	30,60,90,120,150,180,210,240,270,300 Seconds and Off( <b>OFF</b> )
	Scan Receiver Timer	1-99 Seconds and Continue( <b>Co</b> )
	Scan Delay Timer	1-99 Seconds and Off( <b>OFF</b> )
	Backlight Dimmer	Off( <b>OFF</b> ), Low( <b>Lo</b> ), and High( <b>Hi</b> )
	Call Tone	1-5 and Off( <b>OFF</b> )
	Bluetooth Compatible Operation (Optional Model only and the basic model does not have this function)	On( <b>ON</b> ) and Off( <b>OFF</b> )

## \* Bluetooth pairing (Optional model only) :

1. In the Menu setting mode, select Bluetooth compatible operation and turn it on.
2. Confirm this selection by PTT press or just wait for about 10seconds.
3. Turn off the transceiver and pressing and holding the backlight(BL) button turn on the transceiver again. The transceiver is on the pairing mode.
4. Arrange your Bluetooth headset and enter the pairing mode. Press and hold (or follow any other instruction given by your headset supplier) the proper key until the LCD of the transceiver displays OK ( **bt OK** ).
5. The transceiver automatically returns to the stand-by mode and the Bluetooth is active now.

# Transceiver Controls and Functions

## EMG & Keypad Lock

LOCK

9/19

## 10) Emergency Channel and Keypad Lock

**Emergency Channel(9/19)** : Momentarily press this EMG button to directly go to the emergency channel.(9 or 19 channel depending on the band where you are now). The EMG icon will display and only squelch and volume will work. Other keys and functions are all locked.

To return to the previous operation mode, momentarily press this EMG button again.

**Keypad Lock:** Press and hold this button to activate and deactivate the keypad lock function. The “LOCK” icon shows up on the LCD. The volume knob, squelch knob and emergency button are working normal during this keypad lock being operated.

## Squelch Adjuster & DSS

SQUELCH



## 11) Squelch Adjuster and DSS (Dynamic Squelch Tuning System)

**Squelch Adjuster:** Turn this knob counter-clockwise until you hear the background noise and then turn the knob to the opposite direction until the noise disappears. This way you are able to get the best receive sensitivity.

**DSS:** In FM mode, turn the knob counter-clockwise until you hear the click. The squelch level of your transceiver is dynamically adjusted to get the best receive condition.

## Antenna Connector

ANTENNA



## 12) Antenna Connector

Insert the male connector of the antenna cable into this female connector.

## EXT Jack

EXT



## 13) External Speaker Jack

Your external speaker will be activated by connecting through this jack. This will make your built-in speaker turned off(The external speaker is not supplied).

## Power 13.2V DC

POWER  
13.2V DC



## 14) Power 13.2V DC

Connect your power supply cable to this power connector.

# LCD Display & Microphone

## 5. LCD Display

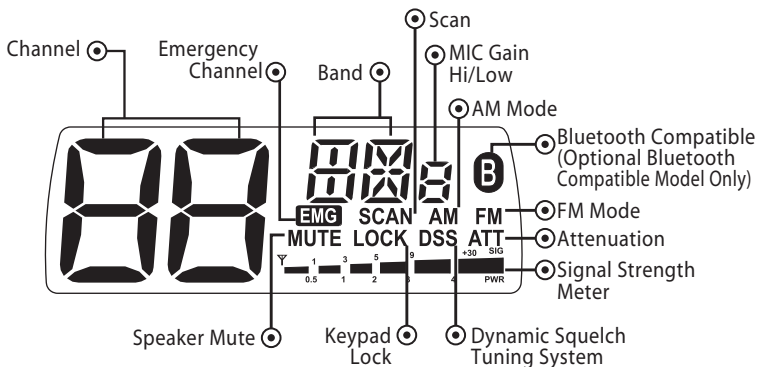

## 6. Microphone

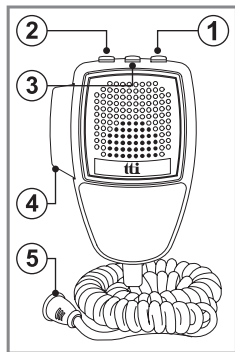

- 1 Up Button : Use this button to change the channels upward.
- 2 Down Button : Use this button to change the channels downward.
- 3 Mute and Lock Button :  
**Speaker Mute:** Momentarily press this button to make the transceiver speaker mute.  
**Keypad Lock:** Long press of this button locks the up button and down button of the microphone. Also, this lock works same as the lock button on the transceiver front panel.
- 4 PTT Button : While pressing this button, you can transmit.
- 5 6 Pin Microphone Connector : Connect this to the microphone jack on the front panel of the transceiver.

# Trouble Shooting

## 7. How to operate the Transceiver

- 1) Make sure the microphone is connected to the microphone jack.
- 2) Make sure the power cable is connected properly.
- 3) Make sure the antenna is connected to the antenna receptacle.
- 4) It is better to put the squelch control knob turned fully counter-clockwise.
- 5) Turn on the transceiver and control the volume knob.
- 6) Adjust the squelch control to the optimum level.
- 7) Select your desired channel..
- 8) To transmit press the PTT button and speak to the microphone.
- 9) Release the PTT button to receive.

## 8. Trouble Shooting

If you experience problems with your TCB-900 transceiver, first check the power supply source. Poor connection of the power supply source can cause problems such as no transmission, no reception or poor reception, and weak or no sound. Ensure that the microphone and antenna are also well connected. If this does not solve the problem, reset your transceiver as follows.

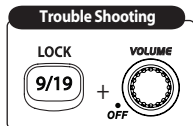

- 1) Switch off the transceiver.
- 2) Pressing EMG(9/19) button, switch on the transceiver.
- 3) Wait for a while until the reset display disappears.

This will reset the transceiver, so all the memories are erased and the parameters return to the initial factory setting.

This should fix most problems. In case of further difficulty, please consult your dealer or visit our website.

## 9. CE Declaration

**C E 0678** CE versions of the TCB-900 which display the CE symbol on the product label, comply with the essential requirements of the European Radio and Telecommunication Terminal Directive 1999/5/CE.

# Safety Requirement



This warning symbol indicates that this equipment operates in non-harmonised frequency bands and/or may be subject to licensing conditions in the country of use. Be sure to check that you have the correct version of this radio or the correct programming of this radio, to comply with your national licensing requirements.

This unit can be used without license and charges in; Austria, Belgium, Bulgaria, Cyprus, Czech, Denmark, Estonia, Finland, France, Germany, Greece, Hungary, Iceland, Ireland, Italy, Latvia, Lithuania, Luxembourg, Malta, Netherlands, Norway, Poland, Portugal, Romania, Slovakia, Slovenia, Spain, Sweden, Switzerland, and U.K.

## 10. Safety Requirement

---

The power cable is for 13.2V DC only. Be sure the transceiver is off before connecting the leads of the power cable to the power supply. It is important to observe the polarity even if the unit is protected against the accidental inversion :

- \* Red : Positive pole (+)
- \* Black : Negative pole (-)

The same colors are present on the battery and in the fuse box of the car.

The unit must be wired for the negative ground only.

To avoid damage, do not operate your CB radio without connecting a proper antenna.

# Specifications

## 11. Specifications

<b>General</b>	
Channel	40 (See the frequency band chart)
Frequency Range	26.96 MHz ~ 27.99125 MHz
Operating mode	F3E (FM), A3E (AM)
Frequency Control	PLL Synthesizer
Frequency Tolerance	0.002%
Operating Temperature Range	-10 to + 55°C
Microphone	Plug-in Type
Input Voltage	12/24V DC $\pm$ 10%
Size	140 (W) x 186 (L) x 37(H)
Weight	990 g
Antenna Connector	SO-239 type
<b>Transmitter</b>	
Power Output	Duty cycle 10% 4 Watts @13.8V DC
Modulation	AM: from 85% to 95% FM: 1.8KHz $\pm$ 0.2KHz
Frequency Response	300Hz to 3000Hz
Output Impedance	50ohms, Unbalanced
Harmonic Suppression	Less than -54dBm
Current Drain	AM Full Mod. 1.6A Max.
<b>Receiver</b>	
Receiving System	Dual conversion super-heterodyne
IF Frequencies	Double Conversion 1st 10.695MHz/2nd 455KHz
Sensitivity	1.4 $\mu$ V for 10dB(S+N)/N in AM Mode 0.8 $\mu$ V for 20dB SINAD in FM Mode
Audio Output Power	2.0W @ 8 Ohm
Audio Distortion	Less than 8% @ 1KHz
Image Rejection	More than 60 dB
Adjacent Channel Rejection	More than 60 dB
Conducted Spurious	Less than -57 dBm
Frequency Response	300 to 2500Hz
Built-in Speaker	8 Ohms, round
Squelch	Adjustable; Threshold less than 1 microvolt DSS: Less than 2 microvolt

\* Specification is subject to change without prior notice.



# Restrictions on the use

## 12. Restrictions on the use

COUNTRY	Settings	Use restrictions and other comments
BELGIUM SWITZERLAND	EU F EC	40 Ch - 4W FM - Individual licence is required 40 Ch - 4W AM - Individual licence is required
DENMARK,NORWAY LUXEMBOURG,CZECH	EC	40 Ch - 4W FM - Free use
FINLAND,PORTUGAL FRANCE,NETHERLANDS	EU F EC	40 Ch - 4W FM - Free use 40 Ch - 4W AM - Free use
GERMANY	D	80 Ch - 4W FM 40 Ch - 4W AM
	EU	40 Ch - 4W AM
	EC	40 Ch - 4W FM
fx Allowed: from 26.960 to 27.410 MHz "BAPT 222 ZV 104"		
GREECE	E EU F I EC	40 Ch - 4W FM - Free use 40 Ch - 4W AM - Free use
	T/R 20-02	
IRELAND	E EU F I EC	40 Ch - 4W FM - Free use 40 Ch - 4W AM - Free use
	S.I. No 436 of 1998. WIRELESS TELEGRAPHY ACT, 1926 (SECTIONS) (EXEMPTION OF CITIZENS' BAND (CB) RADIOS) ORDER, 1998	
ITALY	E EU F I EC	40 Ch - 4W FM - General authorisation is required 40 Ch - 4W AM - General authorisation is required
	I2	34 Ch - 4W FM 34 Ch - 4W AM(ERP) *AM mode allowed on ch1-23 only
	PNF issued on DM 08.07.02 NOTES 49 A-B-C-D-E-G	
SPAIN	E EU F EC	40 Ch - 4W FM - Individual licence is required 40 Ch - 4W AM - Individual licence is required
	Art. 57 - Law 11/1998 dated 24th April	
SWEDEN	EU F EC	40 Ch - 4W FM - Free use 40 Ch - 4W AM - Individual licence is required
	UK	EC
UK-RA-MPT 1382/MPT1320; UK-R&TTE - S.I.L. 2000:730		
POLAND	PL EU EC	40 Ch - 4W FM / AM - Free use

# Declaration of Conformity

## 13. Declaration of Conformity

We, TTI Tech Co.,Ltd (4F, JuWon Bldg, 1188, Gaepo-dong, Gangnam-gu, Seoul, Korea) declare on our sole responsibility that this equipment complies with the essential requirements of the Radio and Telecommunications Terminal Equipment Directive, 1999/5/EC, and that any applicable Essential Test Suite measurements have been performed.

Kind of Equipment : MOBILE CB TRANSCEIVER

Type-Designation : TCB-900

Version (where applicable):

This compliance is based on conformity with the following standards, specifications or documents:

ETSI EN 300 135-1 V1.2.1:2008-02

ETSI EN 300 135-2 V1.2.1:2008-02

ETSI EN 300 433-1 V1.3.1:2011-07

ETSI EN 300 433-2 V1.3.1:2011-07

ETSI EN 301 489-1 V1.9.2:2011-09

ETSI EN 301 489-13 V1.2.1:2002-08

EN60950-1:2006+A11:2009+A1:2010+A12:2011



N. Y. Kim  
Director

CE Marking

This radio is marked  **€0678**  adjacent to the serial number.